

DRG.NO

EF250SM-8-B3

FRAME

EF250SM-8

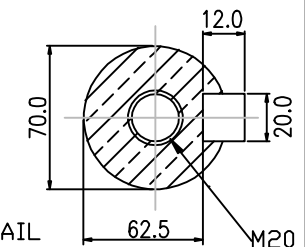
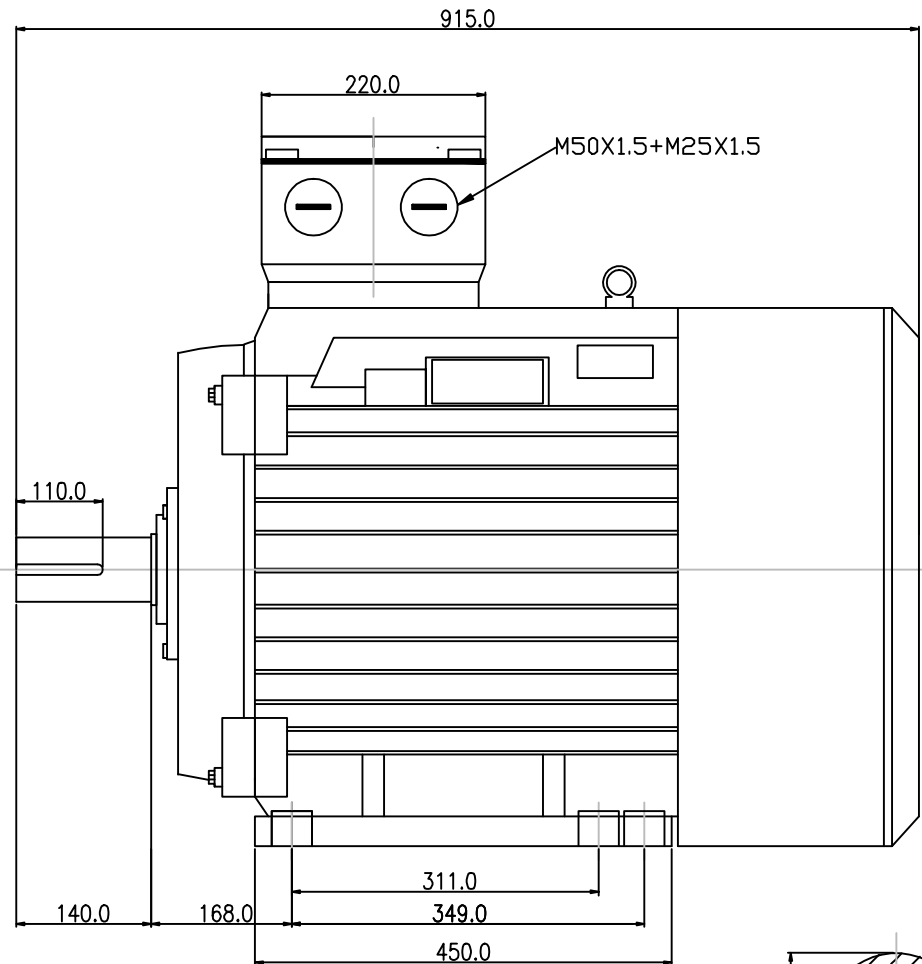
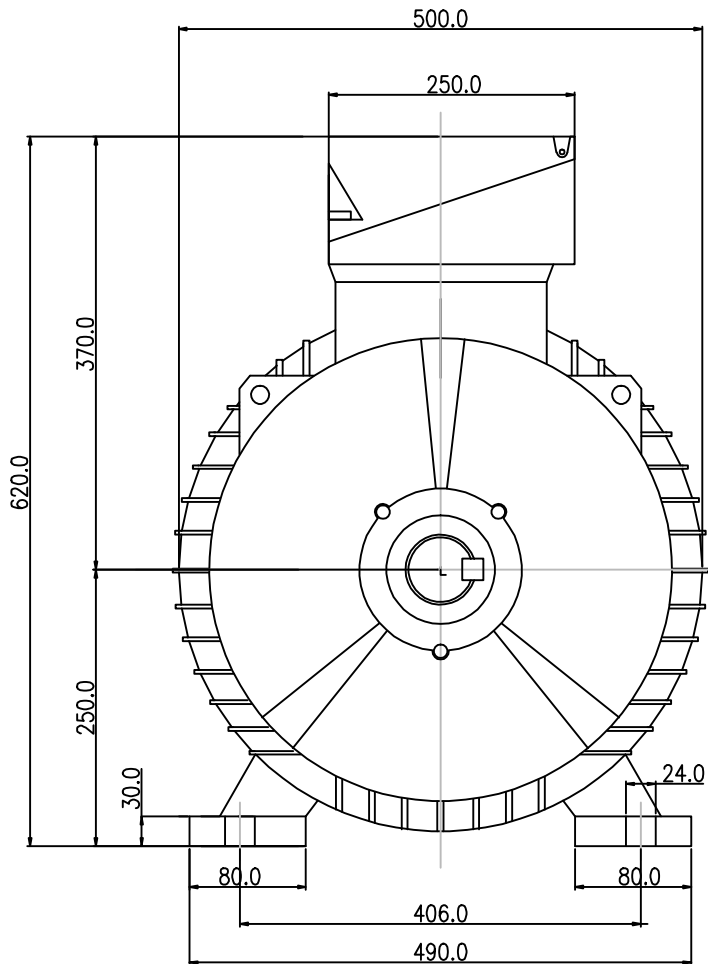

SHAFT DETAIL



59 PEEL ROAD
O'CONNOR WA 6163
Ph: (08) 9314 7666
Fax: (08) 9337 2505
www.ems-perth.com



DRAFTING
STANDARD
AS 1100

SIZE
A4

ALL DIMENSIONS ARE IN mm
UNLESS OTHERWISE SPECIFIED
TOL. 1 PLACE DECIMAL ± 0.25 ANGLE $\pm 0.30^\circ$
2 PLACE DECIMAL ± 0.13

MATL SPEC

TITLE
THREE PHASE INDUCTION MOTORS-TOP TERMINAL BOX
(FOOT MOUNT B3 EF250SM-8 70mm)

DRN	NL	DATE	8.12.08
CHK		APPD	
SCALE	NTS		

DESCRIPTIONS
SHAFT TYPE EF250-8 70mm

BRAND	REM X	
DRG NO	EF250SM-8-B3	REV
CODE No.		